



Interamente realizzata con profili in alluminio verniciato e con coperture in PVC oscurante pretensionato o in PVC Valmex oscurante gofrato oppure in PVC Opatex bicolore, la struttura è addossata.

La MP 5% e' l'unica pergola che puo' avere il 5% di pendenza garantito dal nuovo sistema brevettato VA.ILA. Spa.

Tale sistema e completamente automatico ed e composto da due motori centralizzati per avere un perfetto tensionamento del telo.

Dotata di gronda frontale autoportante e di guarnizione antigoccia fornite di serie.

La struttura è predisposta per l'installazione delle coperture laterali di chiusura.



Inclinazione minima consigliata per un corretto funzionamento 5%.

Dimensioni Massime		
1 Modulo	500	700
1 Modulo	400	800
2 Moduli	900	600
3 Moduli	1000	450



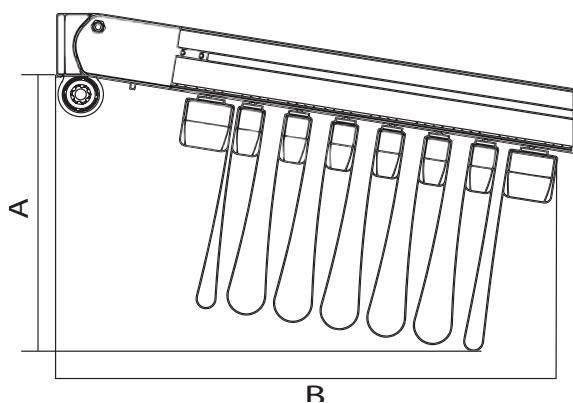

SP	A* CM	B* CM	P =
150	33,5	51	3
200	35	58	4
250	36,5	65	5
300	38	72	6
350	39,5	79	7
400	41	86	8
450	42,5	93	9
500	44	100	10
550	44,5	107	11
600	47	114	12
650	48,5	121	13
700	50	128	14

*VALORI INDICATIVI

SP SPORGENZA
 A INGOMBRO TELO IN ALTEZZA
 (variabile secondo inclinazione)
 B INGOMBRO TELO IN SPORGENZA
 P NUMERO PROFILI PORTATESSUTO
 (COMPRESO PROFILO PORTATESSUTO TERMINALE)

La distanza tra i portatessuti non è mai superiore a cm. 60

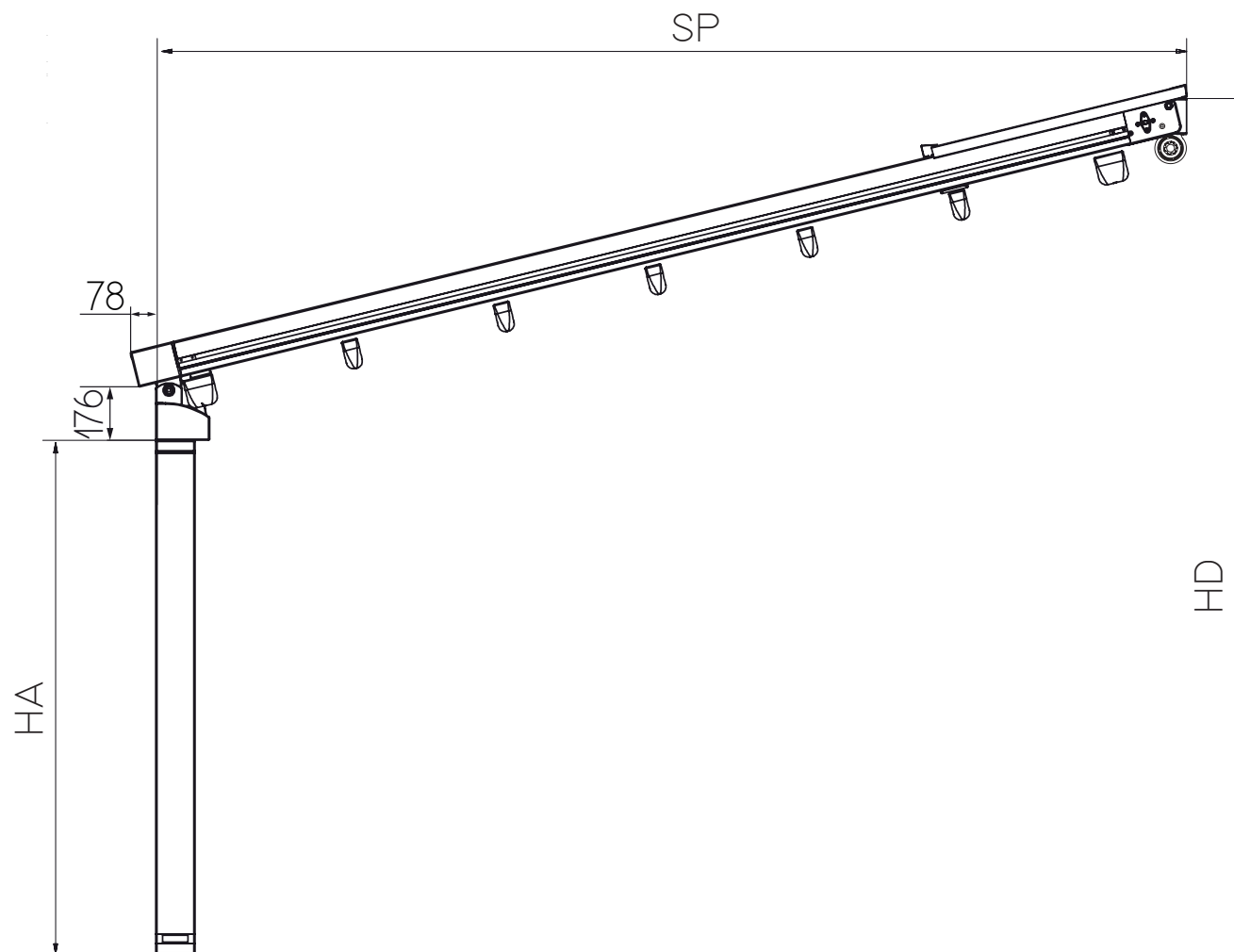

HA= Altezza avanti intesa sotto gronda

HD= Altezza dietro intesa sopra staffe (nel caso in cui fosse presente il tettino intesa sopra tettino)

SP= Sporgenza intesa da parete a esterno gamba

STAFFA UNIVERSALE

Ingombri e interasse fori

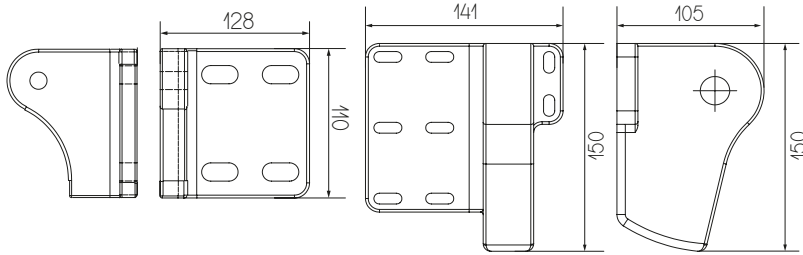

PROFILO GUIDA

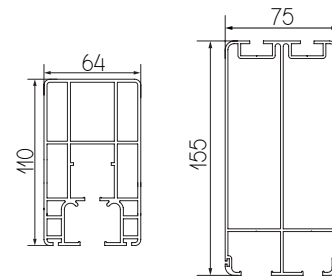

PORTATESSUTO

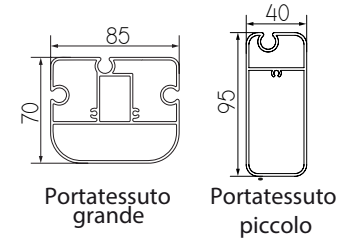

PROFILO GRONDA AUTOPORTANTE

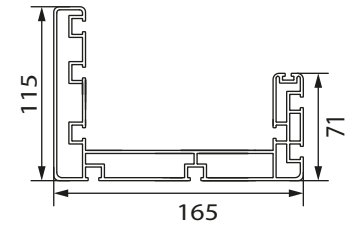

PROFILO GAMBA

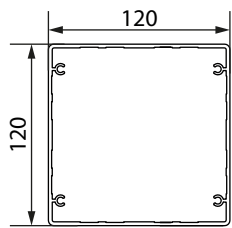

Piede con scarico acqua integrato

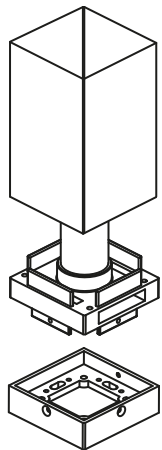

Innesto gamba

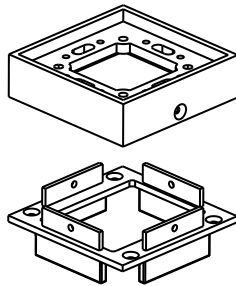

Piede

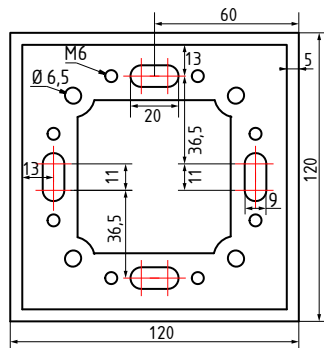

Installazione a parete

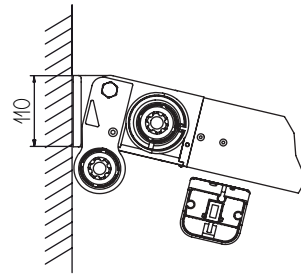

Installazione a soffitto

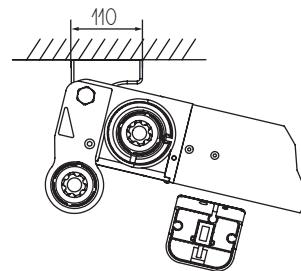

Sistema trazione telo



Traversa tettino

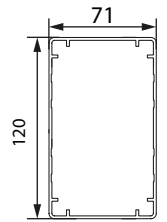

Innesto traversa

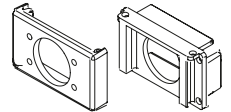

Tendicinghia posizionata all'interno del puntale

